



YLI ELECTRONIC

Electric Bolt with Cylinder

Model: YB-620(LED)



Parameters

Lock Body	150Lx36Wx57H(mm)
Magnetic Plate	150Lx36Wx3H(mm)
Bolt	16(prolongation)*20(diameter)(mm)
Voltage	12VDC
Current	Start 1000mA,Standby 350mA
Time Delay	0/3/6/9 sec
Feature	Fail secure
Signal Output	Door signal(NO/COM) Lock signal(NO/NC/COM)
LED	Light on indicates locked, light off indicates unlocked
Detection Distance	Within 3-8mm
Suitable for	Wooden door, metal door, fireproof door, glass door
Material	304 stainless steel, wire draw finishing
Weight	1.25kg

Dimensions

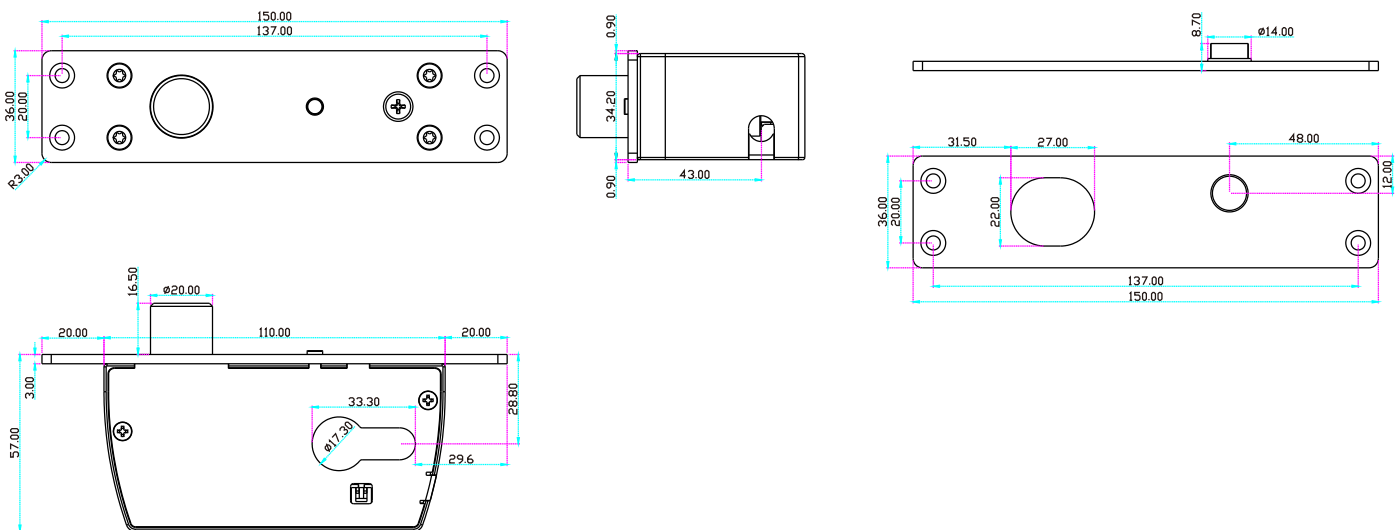

Optional Accessory

Single side cylinder or both side cylinder, other sizes are available too: 80/90/100/110/120mm.

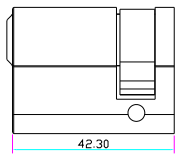
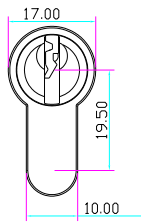

Single side cylinde

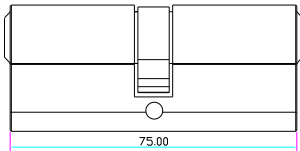
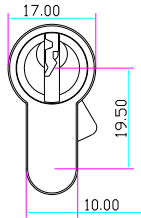

Double side cylinder

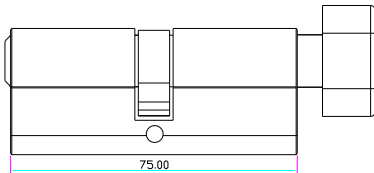
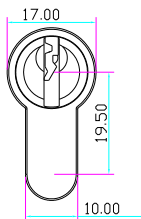

Single side cylinder with Thumb

Wiring Diagram

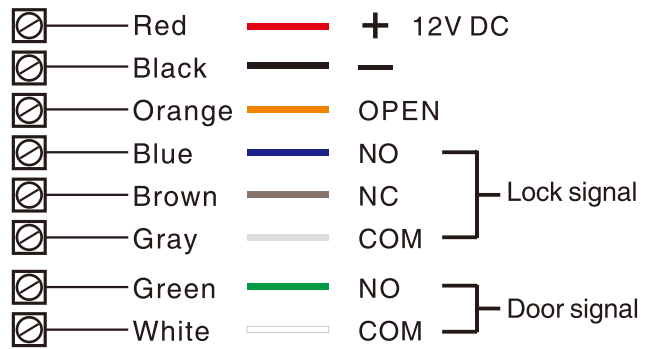

Time Delay

Adjust the delay time for locking automatically 0/3/6/9 secs.



0.0 SEC



6.0 SEC



3.0 SEC



9.0 SEC

Installation steps

