

Since 1968

**COMMAX**  
SmartHome & Security

# User Manual

Color video door phone CDV-70QT

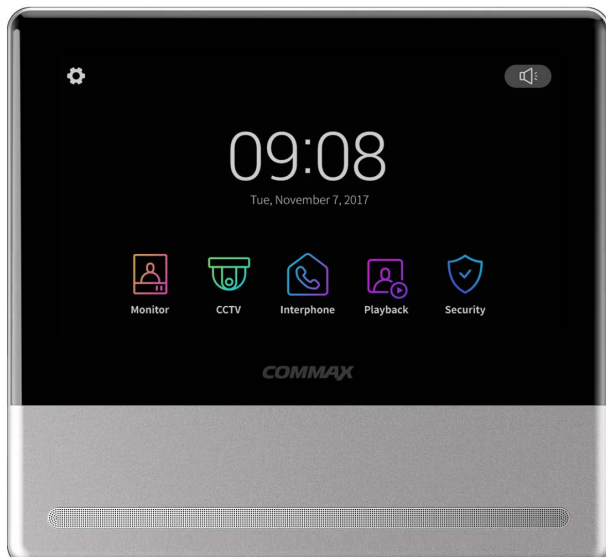

[www.commax.com](http://www.commax.com)

**COMMAX Co.,Ltd.**



- Thank you for purchasing COMMAX products.
- Please carefully read this User's Guide (in particular, precautions for safety) before using a product and follow instructions to use a product exactly.
- The company is not responsible for any safety accidents caused by abnormal operation of the product.



# Table of contents

1. Greetings . . . . .	1
2. Warnings and caution . . . . .	2
3. Parts names . . . . .	4
4. How to use the product . . . . .	5
5. Using Smartphone . . . . .	20
6. How to install . . . . .	21
7. Wiring diagram . . . . .	22
8. Package contents . . . . .	23
9. Specifications . . . . .	24
10. Safe operation guide . . . . .	24



## 1. Greetings

- Thank you for Purchasing COMMAX Products
- Please carefully read this User,s Manual (In particular, pre cautions for safety) before using a product and follow instructionsto use a product exactly.



## 2. Warnings and caution

Please follow the things described below in order to prevent any danger or property damage.

**Warning**  
It may cause a serious damage or injury if violated.

**Caution**  
It may cause a minor damage or injury if violated.

- Prohibition.
- No disassembly
- No touch
- Must follow strictly.
- Shows plugging out the power cord without an exception
- Shows the warning and caution for an electric shock.
- Shows the warning and caution for a fire.

### Warning

**Power & Installation**

Please don't use several products at the same time on one power socket.

- It may cause a fire due to an abnormal overheating.

Please don't bend the power cable excessively or it may cause an electric shock.

- fire when using a damaged power cable.

Please don't handle the power cable with a wet hand.

- It may cause an electric shock.

Please plug out the power cable from the socket when not using it for a long period of time.

- It may shorten the product lifespan or cause a fire.

Please don't install the product in the place where there is much oil, smoke or humidity.

- It may cause an electric shock or fire.

Please don't install the product with the lightning and thunder.

- It may cause an electric shock or fire.

Please don't use and connect this product with other products with different rated voltage

- It may cause a disorder or fire.

When installing the product that generates heat, please install the product away from the wall (10cm) for the ventilation.

- It may cause a fire due to the increased internal temperature.

## ⚠ Warning

### Cleaning & Use

Please don't disassemble, repair or rebuild this product arbitrarily (please contact the service center if a repair is needed).

- It may cause an electric shock or fire.



If an abnormal sound, burning smell or smoke is coming out of the product, please plug out the power cable and contact a service center.

- It may cause an electric shock or fire.

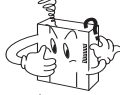

Please don't insert any metallic or burnable materials into the ventilation hole.

- It may cause an electric shock or fire.



Please use only the designated batteries for the products of using DC power.

- It may cause an electric shock or fire.



## ⚠ Caution

### Power & Installation

Please plug the power cable firmly into the inner end

- It may cause a fire.

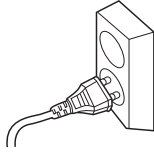

Please hold the plug tightly when unplugging the power cable (a part of the copper wire may be disconnected if the grabbing is only made on the cord when pulling out the cable).

- It may cause an electric shock or fire



When connecting the power cables after cutting the cable, please install the product with power off

- It may cause an electric shock or fire



When installing the product, please fix it firmly while using the wall-mounting unit and screws.

- It may cause an injury from the falling object.

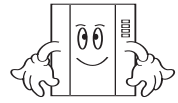

Please be careful when using an AC circuit breaker since there is a possibility of an electric shock.

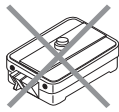

Please check the use voltage and current for the DC-only products and use the appropriate rectifier.

- It may cause a fire.



Please avoid direct rays of the sun or heating devices at a time of installation.

- It may cause a fire.



Please don't install the product on an unstable place or small support board.

- It may cause an injury if it falls down while in use.



### Cleaning & Use

When cleaning the product, please rub it with a soft and dry cloth after plugging out the power cable. (Please don't use any chemical products such as wax, benzene, alcohol or cleanser.)



Please don't drop the product on the ground and don't apply a shock.

- It may cause a failure.

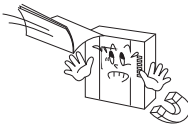

Please use the designated connection cable within the maximum calling distance designated for the product

- It may reduce the product performance.





### 3. Parts names

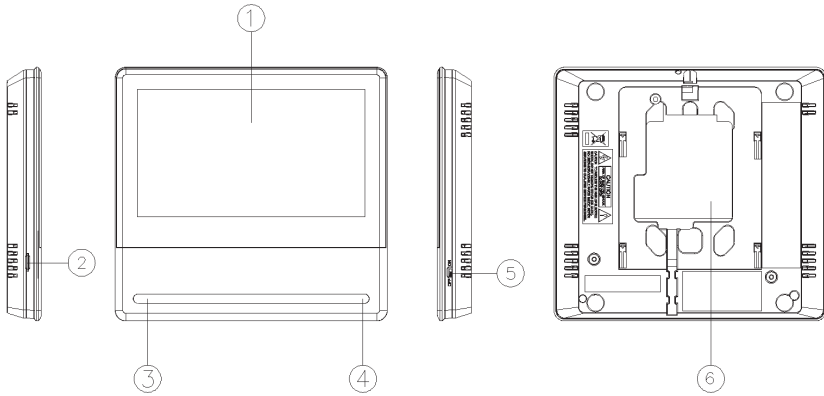

No	Parts	No.	Parts	No.	Parts
1	Touch LCD	2	Micro SD card slot	3	Speaker
4	Microphone	5	Power switch	6	Connection terminal

## 4. How to use the product

### 4-1 Main screen



No.	Menu	Details
1	Monitor	View the door camera - You cannot use it if door camera is not connected
2	CCTV	Monitoring CCTV - You cannot use it if CCTV is not connected
3	Interphone	Move to Interphone menu
4	Playback	Move to the list of recorded images and videos
5	Security	Move to Security menu.
6	Option	Move to the menu 'Options'
7	Mute Icon	Indication of mute status
8	Date & Time	Indication of Date and Time, Touch to move to the menu 'Set-up'

#### \* Cautions

- Please set up date and time before use.  
. If you do not set up, some problems in saving still-cut image and video-clip might happen.

#### 4-2 Monitor

- The following screen will be shown when calling from door camera or touching the button 'Monitor'
- Max. time : Monitoring (30 sec.), Call and Talk (60 sec.)
- If the camera is not installed, it cannot be executed.

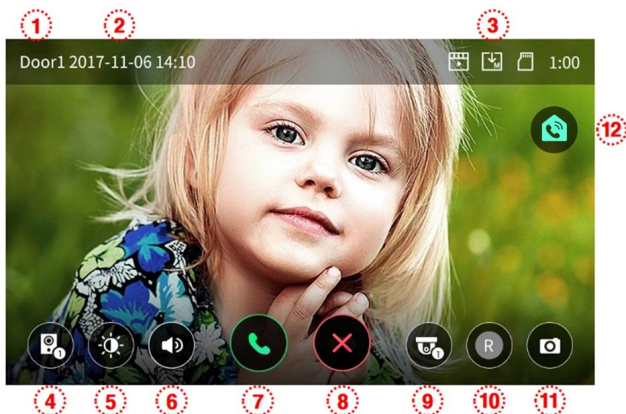

- Selected camera: Selected camera will be shown on the screen.
- Date & Time: Current date and time will be indicated.
- Storage (Saving) icons: Icons for motion detection and recording will be indicated.

- Details of icons



Storage format: Images / Videos (In Motion detection mode)



Storage mode: MANUAL / AUTO



SD card status: Insertion / Full memory

- Split screen view: Split monitoring of door cameras is available.

It's not available to use if there is only one camera installed.

- Image quality adjustment: Display setting for door camera (Door camera #1, #2).

- Brightness/ Luminosity / Chroma adjustment is available after pushing the button.
- The range for adjustment is 0-20. There is a button located on the right upper for initialization.



- Volume control: You can control calling tone volume and receiving tone volume.

- Push the button in order to adjust the volume.
- Volume adjustment level: Ring (0-3), Speaker (1-3)



- ⑦ Call connection: To call & answer the call.  
 - After call is connected, 7 & 8 buttons will be changed as follows.



Door open (No.7): To open the door.



End call (No.8): To end a call.

**\* Cautions**

If you set 'Fast mode' in the menu option 'Open door mode', there will be shown the 'Door open' icon. In this case, it is possible to open the door without connecting the door..

- ⑧ Call cancellation: To cancel the call when you get a call from door or lobby.  
 ⑨ CCTV monitoring : To check CCTV video during call or monitoring.  
 ( If CCTV is not connected, the icon is not displayed. )  
 ⑩ Video-clip storage (saving): To store (save) a video-clip.

- When you touch a button, you can store a video-clip.  
 (When you set an auto-storage mode, a video-clip is automatically stored)
- Max 120 seconds per one storage (Call connection 60 seconds + Calling 60 seconds)
- The below icon will be shown during storage, and the remaining time will be shown on the right upper.



- If you want to stop storage, you should touch the icon.

- ⑪ Image (Still-cut image) storage: To store (save) a still-cut image.  
 - When you touch a button, you can store images. And the below icon will be shown during storage.



- ⑫ Interphone : touch the Interphone button, and it calls the connected interphone

**\* Calling of visitor**

- ① When a visitor calls from entrance, you can hear calling tone(sound) and the visitor's image appears on the monitor.  
 - Max 60 seconds for call connection time.  
 - When you set an auto-storage mode, video-clip and image are automatically Stored.
- ② When you touch a call connection button, you can talk to a visitor. And when you touch a door-open button, the door will be opened.  
 - Max 60 seconds for calling time.  
 - While a video-clip is being stored, you can re-store a video-clip for 60 seconds from call-connecting moment.  
 - You can open the door when the screen is on. And, it is possible only when door camera is interlocked with door release function.



- When you touch a door-open button, the below door-open icon will be shown in the center of screen. But door-open sound will not work during video-clip and image storage.

- ③ When the other call comes from the other entrance, the current call is finished and the other call is connected.  
 ④ When you press a call-end button, the call is end. And the main screen will be shown.



### \* Calling of Interphone

- ① In case of installing additional interphone, when a visitor calls from door camera, a calling tone(sound) will be ringed in the interphone as well.
  - Max 60 seconds for call and talk time
- ② When you pick up the handset, it's available to talk with door camera.
- ③ During a call, press the door open button to open the door.  
(In case door camera is interlocked with door release function)
- ④ Put the handset back on and the call ends.
  - The interphone call ends when the connected video phone call finished.

### 4-3 CCTV

- When you touch a CCTV button, the below screen will be shown.
- **Monitoring time is max. 60 seconds. The video-clip storage can be proceeded within 60 seconds.**
- You cannot use CCTV functions if cameras are not installed.

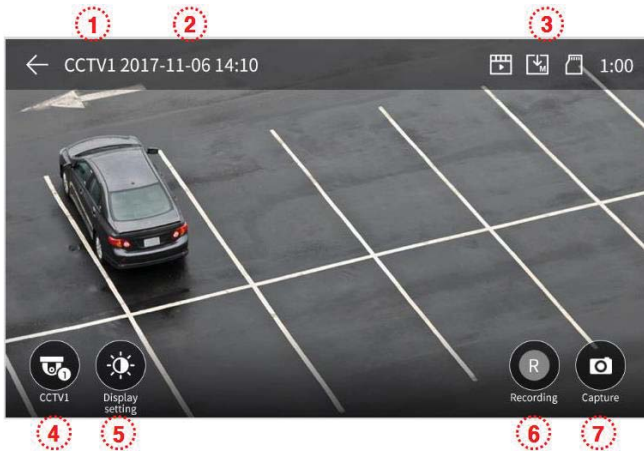

- ① CCTV sign: To show the current working CCTV.
- ② Date & Time: Current date and time will be indicated.
- ③ Icon set: To show motion detection and video storage. (Monitor section for more details)
- ④ CCTV screen change: To see CCTV 1 screen and CCTV 2 screen.
  - You cannot use this function when only one camera is connected.
- ⑤ Video quality adjustment: To change Brightness/Light & Shade/Chroma.  
(Monitor section for more details)
- ⑥ Video storage: To store (save) a video-clip.
  - When you touch a button, the storage will be started.
  - The below icon will be shown during image storage. And the remaining time will be shown on the right upper.



- If you want to stop storage, you should touch the icon.

⑦ Image storage: To store (save) a still-cut image.

- When you touch a button, you can store images. And the below icon will be shown during storage.



**\* Reference(Door camera and CCTV are same in the below issues.)**

① Video-clip cannot be stored while SD card is not inserted.

- The images can be stored in the monitor's embedded memory. (Max 50 still-cut images).  
 - You can use as below when you need back-up of images which are stored in the monitor's embedded memory.

1) Turn off the monitor and then insert SD card. Turn on the monitor. And then the images are automatically stored in SD card.  
 (After a backup, files will be automatically deleted.)

2) You can check the file through your computer. ([backup folder] in SD card)

3) You can check the date, storage time and information (camera source, saving format, emergency storage).

- File name: YYMMDD\_HHMMSS\_AB.AVI or JPG

Note : The meaning of the last two digits (denoted by AB)

A : 1 - DOOR1 / 2 - DOOR2 / 3 - CCTV1 / 4 - CCTV2

B : 1 – MANUAL(manual recording)/2 – AUTO/3 - MOTION/4-ALARM

ex : The meaning of the file '180109\_045740\_12.avi'

-> Video automatically recorded by visitors calling from door1 on January 9, 2018 at 4:57:40

② The image and video-clip can be stored while SD card is inserted. The maximum storage size depends on the capacity (storage size) of SD card.

**4-4 Interphone**

- When you touch the Interphone button, it calls the connected interphone and the following screen is displayed.

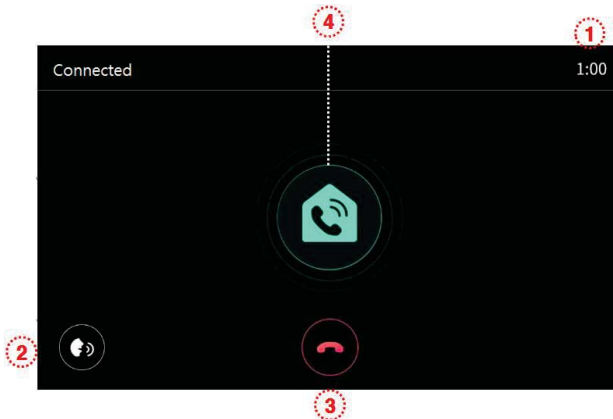



① Call & Talk time : To show remaining call and talk time.

- ② Volume control : To control receiving volume (1-3 level).
- ③ Call end : To finish call connection and talk.
- ④ Interphone call : The interphone is called only while pressing the call button.  
(A ringtone sounds only while you are pressing and holding)

#### 4-5 Playback

- When you touch Playback button, the below screen will be shown.
- Select the image. (Selected image will be enlarged and video will be displayed.)



- ① Page information : Current page / Total page
- ② Move the page: ◀ : previous page / ▶ : next page
- ③ File information  
 : Image file,  : Video file,  : New file
- ④ Emergency Recording: File saved when emergency occurs by sensors.  
 - When 'Auto Rec' is set in Security menu, CCTV video is recorded for 10 secs when emergency occurs.  
 (CCTV1 is automatically saved when sensor # 1 is detected and CCTV2 is saved by sensor # 2.  
 But, if there is no SD card inserted, only steel cut image is saved and the sensor need to be connect to CCTV.)  
 - If visitor call is received during emergency, the video of visitor will be saved automatically on 'Auto Recording' setting or also can be saved manually.  
 (During emergency situation, the visitor communication is restricted and only the visitor image can be checked.)

- To verify images.



- ① Storage source & file No.
- ② Left/Right movement : To move the previous/next file.

- ③ Date &Time : Current date and time will be indicated.
- ④ Delete files: To delete images.

- To verify video-clip.

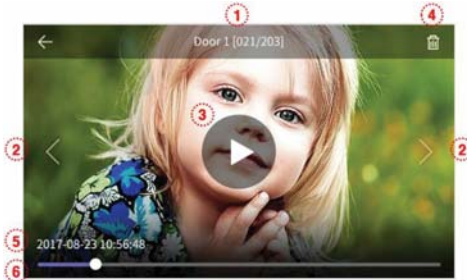

- ① CD Storage source & file No.
- ② CT Left/Right movement: To move the previous/next file.
- ③ Playing the file: To play the current video-clip.  
During playback, the icon is changed by the pause button.
- ④ Delete the file: To delete the current playing file.
- ⑤ Date & Time: Current date and time will be indicated.
- ⑥ Video-clip time indication: The remaining time is displayed

<Note>

- Immediately after inserting SD card, the loading time depends on the number of stored filesize. (please wait a moment)

### 3-6. Security (Can be used with security sensor)

- Touch the Security button to display the following screen.
- Using this function, the door is detected when the sensor is connected.



< Before operation >



< During Operation >

1) Before operating Security mode

※ Caution

Be aware of the password before proceeding.  
You cannot turn off the alarm if you don't know current password. (Factory default : 1234)

- ① Security Sensor 1, Security Sensor 2: Select sensor to operate.
- ② Select check box : If the sensor is selected by check box. (Turn on & Turn off)
- ③ Execute button: Activate the selected sensor. (Please note that the alarm occurs when sensor is detected)
- ④ Emergency log : You can check emergency log.
- ⑤ Auto recording: CCTV is automatically recorded for 10 seconds when an emergency occurs.

- When the function is active (red), the corresponding function is activated. (You can turn off it by click.)
- CCTV1 is recorded in case of sensor 1 emergency, and CCTV2 is automatically recorded in case of sensor 2.  
(If there is no SD card, it will be replaced with steel cut image. If CCTV is not connected to the sensor, it will not be recorded.)

2) During Security mode :

- ⑥ Indicates the security sensor being executed.
- ⑦ End the security function.
  - Press the button and enter the four-digit password. (Factory default password: 1234)
  - If the password is correct, the mode is turned off and the screen returns to the main screen.  
(If the password is incorrect, you can not turn the mode and please progress initialization of the device.)

<Password input screen to turn off the mode>



<Sensor detected screen during security mode>



1) When security alarm occurs

- When a sensor is detected during security mode, an alarm is generated, and the sensor number(Sensor1 or Sensor2) and the time of occurrence are displayed.
- If the emergency situation is canceled, press 'Stop' button at the bottom.  
(You can turn off the alarm if the corresponding sensor is recovered to normal status.)
- When the password input window appears, enter the four-digit password using the key buttons.
- Alarm sound occurs for 3 minutes and then only alarm screen is displayed after then.  
(During the alarm occurs, the calling sound rings by the camera to indicate the emergency situation.)

4-6 Option

- When you touch option button, the below screen will be shown.
- When you select each item, the corresponding sub item is displayed on the right.
- If you do not do any action for 30 seconds after you get in Option menu, the main screen will be shown.

① Recording/Wi-Fi

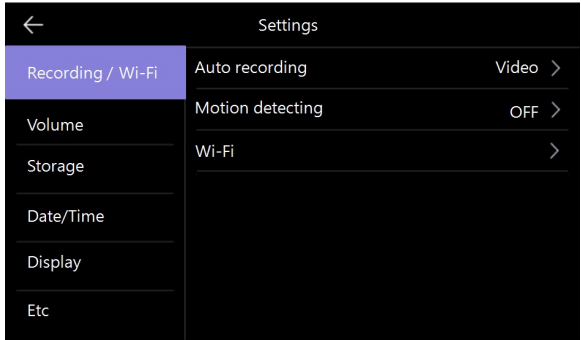

1) Auto recording

- To set the auto save mode. (Select between Photo / Video)  
However, if there is no SD card, video mode cannot be selected.
- This function is only available when a call comes from a door camera (entrance). And you cannot save photos and video-clip manually until the automatic saving is started.
- Selecting OFF disables the auto save function.

2) Motion detecting

- To set motion detection of the previously set camera.
- Functions of each menu are as following.

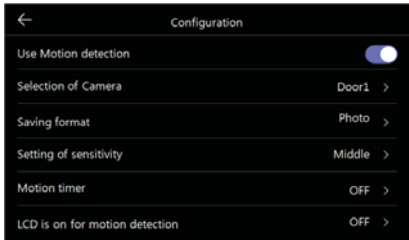

Motion detector: To set enable / disable function.

Select camera: To select camera for monitoring. (Select from Door1/2, CCTV1/2)

Storage format: To select storage method. (Select between Photo / Video)

Sensing sensitivity: To set sensitivity. (Select among High / Middle / Low)

Motion timer: To set up the timer function activation. (Motion detection activation time)

Once activated, you can set the timer, start / end time.

LCD is on for motion detection : During video recording, it shows video on LCD.  
(for 10 seconds)

\* Reference

- When detecting motion, the photo is saved for 1 scene and the video-clip is saved for 10 seconds.
- In the night or dark place, the LED of door camera is always on while this function is working.
- When motion is detected, a push alarm occurs through the mobile phone app. If you set the camera for a part where there are many passersby, it can be inconvenient as a mobile phone alarm.  
(In this case, please change the surveillance camera or do not use motion detection)

### 3) Wi-Fi : Wireless network connection

- Settings -> Recording / Wi-Fi -> Wi-Fi

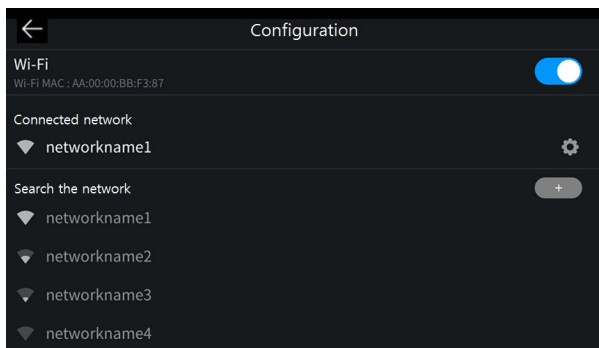

- Wi-Fi connection :

Click the check box to turn on or off Wi-Fi

You can search surrounding network and connect to selected wireless network.

Select the Wi-Fi from the network list of auto-discovered and enter the password to connect

- Add Wi-Fi directly :

When the Wi-Fi you want is not discovered, you can add it entering the Wi-Fi information directly to the list.

Select 'Add Wi-Fi network' icon ('+') at the top of Wi-Fi list.

Enter name of network, , enter the password.

### ② Volume

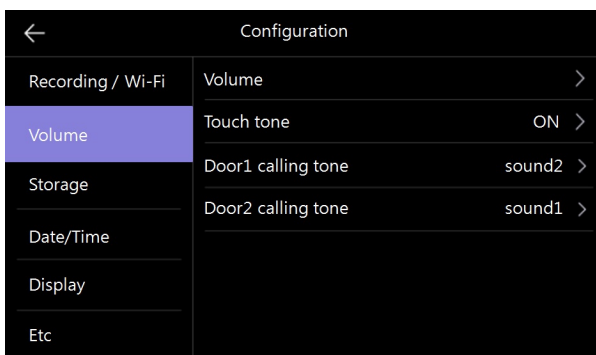

1) Volume

- When individual door camera (entrance) and intercom calls, you can change the calling tone and receiving tone individually.

- You can change the calling tone from 0 (mute) to 3 level and the receiving tone from 1 to 3 level.

- 2) Touch sound
  - To turn on / off the touch tone.
- 3) Interphone calling tone (sound), Door1, Door2.
  - You can select calling tone of interphone and individual door camera. (Door1, Door2)
  - 6 types of calling tones are available.

③ Storage

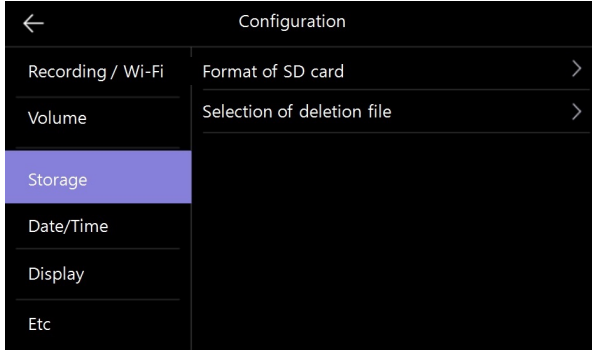

- 1) SD card format
  - To initialize the SD card.
  - It takes about 1 minutes for initialization. (It can be different by types of SD card).
- 2) Selection of deletion file
  - To delete the saved images and videos.
  - The time required varies depending on the file size.

\* Cautions

- It is not available to receive a call while initializing SD card or deleting saved files.

- If you start initialization of SD card, it is not possible to stop it.  
 In case of inevitable ending initialization, it is necessary to start again from the beginning.

④ Date/Time

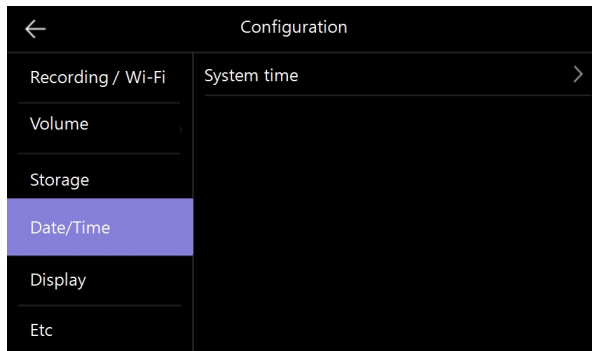



1) System time

- To Set-up Date and Time.
- The changed time will be displayed on the main screen afterward.



⑤ Display

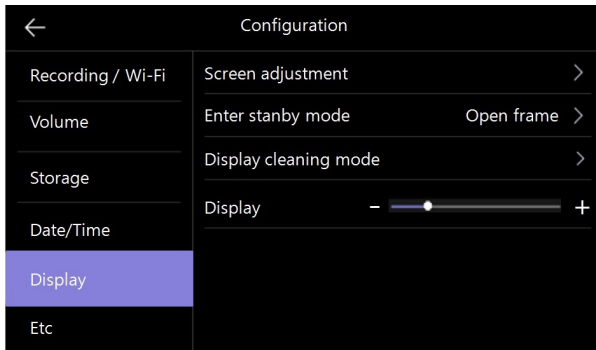

1) Screen adjustment

- Brightness/ Luminosity / Chroma adjustment is available as below picture.

(In this case, you can adjust the display of door camera.)

- The range for adjustment is 0-20 level. There is a button located on the right upper for initialization.



2) Enter standby mode

- Various standby modes can be set.

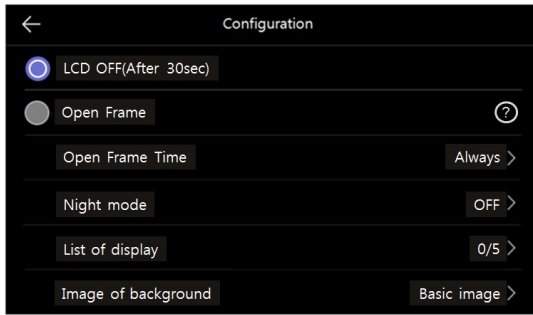

LCD OFF(After 30sec) : To set screen off function when entering standby mode  
 (Activated in 30 seconds after setting)

Open Frame : Enable the Openframe mode while entering standby mode

**\* Caution : If motion detection function is activated, this function does not work.**

- Open Frame Time : You can set the usage time of the wallpaper frame function.

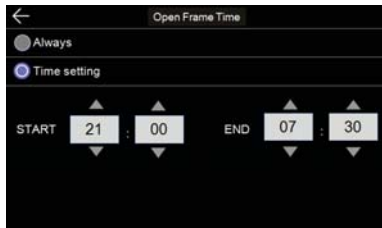
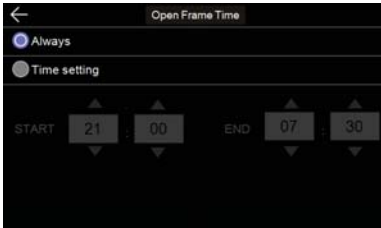

- Night mode : The brightness of the screen is minimized during the set time.



- List of display :

Set which screen to be displayed when the wallpaper frame function is applied.

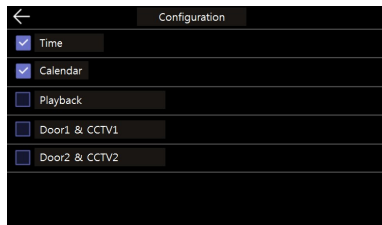

- Image of background :

Set the background image to use when applying the wallpaper frame function.



- No background image : The selected screen is displayed without background images.
- Basic image : The background is set randomly among the images stored in the internal memory.

3) Display panel cleaning mode

- When selecting 'Cleaning mode', the touch screen is deactivated for 30 seconds.

(You cannot stop this function until it is finished.)

4) Display

- Set the brightness of the menu screen.

⑥ Etc

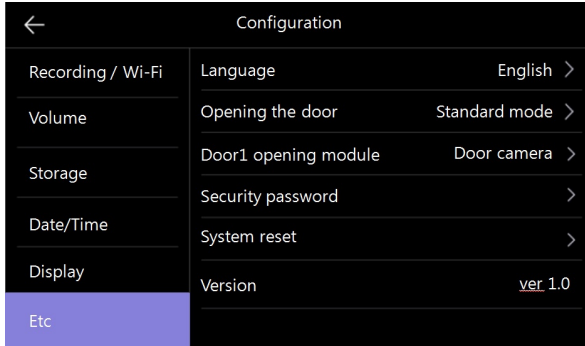

1) Language

- To select the languages.(8 languages.)

한국어	English	русский
español	简体中文	Język polski
Türkçe	Čeština	

2) Opening the door

- To set up door-opening method.

Standard: To open the door during/after the calling.

Fast: To open the door before the calling.

(You do not need to make a call connection to open the door)

3) Door1 opening module

You can choose a module to open door1

- Door camera: Operation of door opening from door camera
- Digital door lock: Open the door from the digital door lock.

4) Security password

- Set the password (4 digits) to be used to disable the security mode or to dismiss the alarm
- You cannot use 0000, 1234, 4321 as a password.

1. Enter password :

Press the button and enter the four-digit password in order using the number key generated. (Initial value: 1234)

(If you lose the password you are using, you can restore to the default value [1234] by executing System reset),

2. Password reset: If the password is correct, the corresponding input window will be generated.

- New password: Enter the new password.
- Confirm password: Press the new password again. (This is to prevent the wrong password being entered)

3. If they are same, the 'apply' button will be activated. Pressing the button will change the password.

\* If you do not want to change during the input, please click the 'X' tab in the top left corner

4) System reset

- To proceed with initialization.

5) Version

- To display the current program version.

\* Reference (Micro SD card information)

1) Available Mirco SD card

- SDHC / SDXC: MAX 128 GBytes (Class 10 or higher)

2) FORMAT (File system) method: FAT32 (Boot the product after inserting a formatted Micro SD card at first use)

3) Maximum storage capacity (Maximum resolution of saved images/videos: 640x360)

- When not using a micro SD card : Only 50 images can be saved (Embedded memory)
- When using a micro SD card : Up to 10,000 images/videos can be stored (However, if the storage file size is large, the maximum quantity may be reduced)

Capacity	Micro SD Card		
	8GBytes	64GBytes	128GBytes(MAX)
Video (Max 120 secs)	160 Files	1400 Files	2800 Files

※ The number of files that can be saved by capacity of the Micro SD card is based on a VIDEO file with a storage time of 120 seconds

\* Cautions for using Micro SD Card

1) Please do not turn on/off and insert/remove Micro SD card during playing, saving or formatting and so on. It might cause malfunction and damage products.

2) The saving capacity of video-clip may vary depending on the environment being stored.

3) When the storage capacity of the micro sd card is full, the oldest files are automatically deleted and the newest files are saved. (Please back up your data when FULL icon is displayed.)

4) MLC type Micro SD Card is recommended.

Storage type: MLC (Capacity up to 10,000 times of video recording and playing)

5) Micro SD cards are consumables with the limited using times

(Please replace the Micro SD card if there is a problem with storage and playback.)



## 5. Using Smartphone

- If an existing user is already connected to the device, new registration with the device is not possible. (In this case, you can re-register the device after initializing the device connection by executing 'Etc' -> 'System reset' in the product setting menu.)

### 1) Sign up



- Install and run the 'COMMAX Hey Call' app using your mobile phone.
- Select 'Sign up' button
- Select your country
- Enter 'Email Address(ID)' and select 'Get Verification Code' button
- Enter the 'Verification Code' sent to you by email.
- Set your password

### 2) Add Device (Registration)

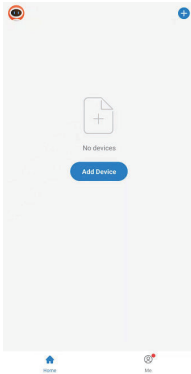

- Wi-Fi connection from your phone (using the same network as your device)
- Select 'Add Device' button
- Select 'Auto Scan' button
- Press the 'Access location' and 'Enable Wi-Fi' button to enable it.
- Select 'Start scanning' button
- When the device is found, click the 'Next' button to complete the registration.

※ If 'Auto scan' is not possible, change to 'Add Manually' for selecting the product and try again

### 3) How to invite members

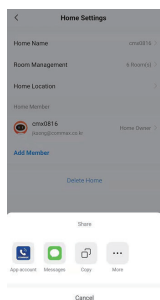

- Select the 'Me' tab at the bottom
  - Select 'My Home' from the 'Home Management' setting menu.
  - Press 'Home Name' to set the name of HOME.
  - Select the home (name) you created.
  - Select 'Add Member'.
  - A selection of how to share the invitation code appears. Select 'Messages'.
- (In this case, the invitation code will be sent via text message.)

※ Invitees can share their device by entering the invitation code in 'Home Management' ->

'Home Join' after installing the app.

(It can be shared by up to 20 people including the administrator.)

### 4) Call using a smartphone

- When a visitor call comes, a push alarm occurs on the smartphone. Access Smartphone
  - Run 'COMMAX Hey Call' app.
  - When the product is connected, the visitor is displayed.
  - Click 'Talk' button to make a call
- ※ If you press 'Open Door' button, a warning message will be displayed. If you click 'Cancel' button, the popup window will close. (Enter the password registered in wall pad and press 'OK' button to open the door.)



## 6. How to install

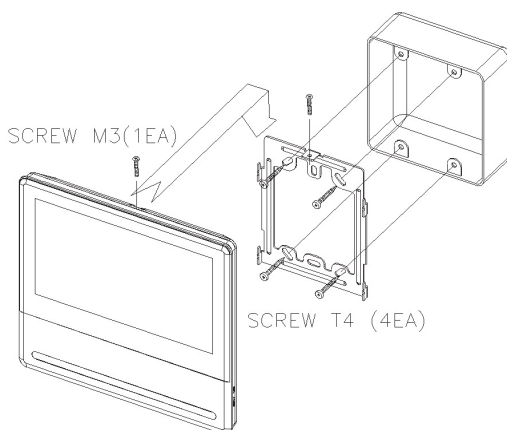

#### Note

- Avoid installing the product in the area of direct sunlight.
- The position of the unit's body should fit the standard height range.  
(Recommended height range is 1450 ~ 1500mm)
- Avoid installing the product exposed to gas exposure, magnetic force, in humid temperatures, as it may damage the condition and performance of the product.

## 7. Wiring diagram

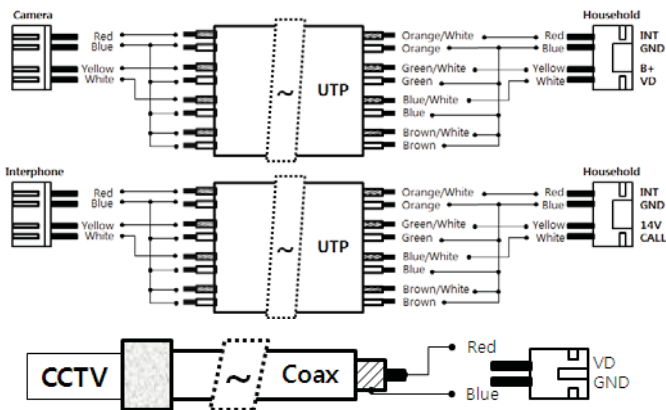
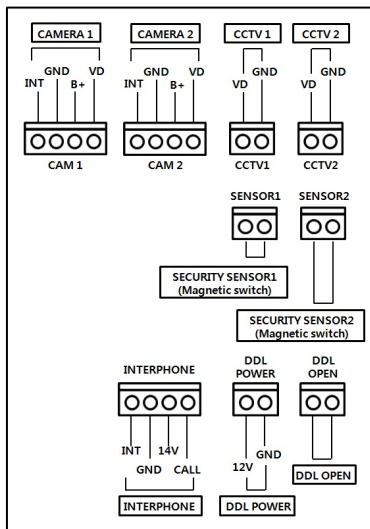

Note:

1. In case, if there is a high-voltage power line in the area of installation, use metal tube coaxial cable for wiring.
2. Beware of wrinkling of line coating and cable stick-outs as it may cause circuit shortage and operation inconvenience.
3. When connecting a monitor with a camera, make sure power switch is turned off.

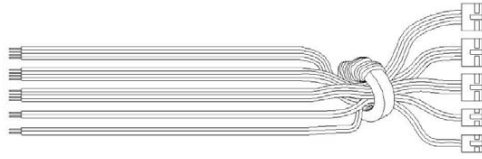

When wiring(Camera, CCTV, Interphone, sensor), please use the core provided in the package to wrap around as shown in the above

## 8. Package contents

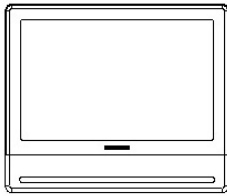

MONITOR

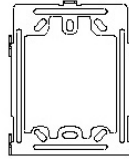

BRACKET



MANUAL



(T) 4X18 mm  
Screw for bracket



(M)3X6mm  
Screw for body

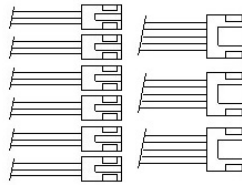

2P(6EA) / 4P(3EA)  
Connector

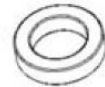

Core EMC

- ① Monitor(CDV-70QT) 1EA
- ② Wall bracket for monitor 1EA
- ③ User Manual 1EA
- ④ Wall bracket mounting screw 4EA
- ⑤ Monitor fixing screw 1EA
- ⑥ Connector 2P 6EA  
Connector 4P 3EA
- ⑦ Core EMC 1EA

\* Connecting Devices

**Door Camera / CCTV : AHD camera (up to 2 Megapixel)**





## 9. Specifications

Model	CDV-70QT	
Transmission Method	Camera- 4 wires, CCTV- 2 wires, DDL RF Module- 4 wires (Power 2 /open 2) Interphone- 4 wires , Sensor- 2 wires	
Power Source	100V-240V~, 50/60Hz	
Consumption	Stand-by : 3.5 W Max : 15 W	
Intercom system	HANDS FREE type (Voice switch circuit)	
Monitor	7" FULL TOUCH LCD	
Video subscription time	Individual door camera monitoring: 30 ±5sec Call connection / Calling: 60 ±5sec	
Wiring Distance	UTP CAT 5e. Standard (ø 0.5)	Camera / CCTV / Interphone <-> Household unit (monitor)
		28 meters (MAX)
		Resistance under 10Ω per 100 meters on UTP Cat 5e
Operating Temp.	0 ~ +40°C (32°F ~ 104°F)	



## 10. Safe operation guide

- Make sure to turn on the product.
- In case if physical damage or operation failure is detected, do not hesitate to contact Service Center.
- All electric power must be blocked by the building blocking device.
- Do not place water bottles or flowerpots upon the product.
- Please, turn the power off when installing or repairing the product.

# **COMMAX**

**COMMAX Co.,Ltd.**

---

513-11, Sangdaewon-dong, Jungwon-gu, Seongnam-si, Gyeonggi-do, Korea  
Int'l Business Dept. Tel. : +82-31-7393-540~550 Fax. : +82-31-745-2133  
Web site : [www.commax.com](http://www.commax.com)

*Edited.2021.08.18*

*Printed In Korea / 2021.08.104*